

Features

3mm Package
 All Plastic Mold Type
 Fast Response Time, Capable of Pulse Operation
 High Power Luminous Intensity
 InGaAIP Technology
 Water Clear Lens

Applications

Outdoor Message Signboard
 Safety equipment

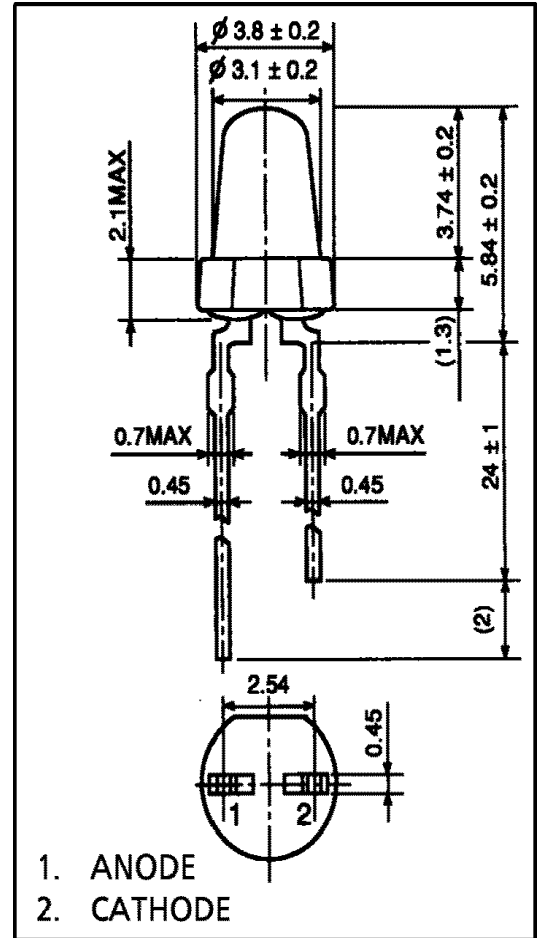

Series Line-Up

Part Number	Color	Material
TLOH160	Ultra Bright Orange	InGaAIP
TLRH160	Ultra Bright Red	InGaAIP
TLSH160	Ultra Bright High Efficiency Red	InGaAIP
TLYH160	Ultra Bright Yellow	InGaAIP

Maximum Ratings (Ta=25°C)

Part Number	Forward Current I _F	Reverse Voltage V _R	Power Dissipation P _D	Operating Temperature T _{opr}	Storage Temperature T _{stg}
TLOH160	50	4	125.00	-30 ~ 85	-40 ~ 120
TLRH160	50	4	125.00	-30 ~ 85	-40 ~ 120
TLSH160	50	4	125.00	-30 ~ 85	-40 ~ 120
TLYH160	50	4	125.00	-30 ~ 85	-40 ~ 120
Unit	mA	V	mW	°C	°C

Company Headquarters
 120 Broadway
 Menands, New York 12204
 Toll Free: 800.984.5337
 Fax: 518.432.7454



Web: www.marktechopto.com | Email: info@marktechopto.com

West Coast Sales Office
 950 South Coast Drive, Suite 265
 Costa Mesa, California 92626
 Toll Free: 800.984.5337
 Fax: 714.850.9314

Electrical and Optical Characteristics (Ta=25°C)

Part Number	PWL nm λP	Material	View Angle 2θ _{1/2}	Luminous Intensity I _v				Forward Voltage V _F				Rev Current I _R	
				min.	typ.	max.	IF@	min.	typ.	max.	IF@	max.	VR@
TLOH160	612	InGaAlP	10°	850.00	2300.00	–	20mA	–	2.10	2.50	20mA	50	4V
TLRH160	644	InGaAlP	10°	850.00	1800.00	–	20mA	–	1.90	2.50	20mA	50	4V
TLSH160	623	InGaAlP	10°	2720.00	4500.00	–	20mA	–	2.10	2.50	20mA	50	4V
TYH160	590	InGaAlP	10°	850.00	4300.00	–	20mA	–	2.10	2.50	20mA	50	4V
–	nm	–	deg	mcd				–	V		–	μA	–

Precautions

- Soldering temperature: 260°C max, soldering time: 3 s max (soldering portion of lead: up to 2 mm from the body of the device).
- If the lead is formed, the lead should be formed up to 5 mm from the body of the device without forming stress to the resin. Soldering should be performed after lead forming.
- This visible LED lamp also emits some IR light. If a photodetector is located near the LED lamp, please ensure that it will not be affected by this IR light.

NOTICE:

- TOSHIBA is continually working to improve the quality and reliability of its products. Nevertheless, semiconductor devices in general can malfunction or fail due to their inherent electrical sensitivity and vulnerability to physical stress. It is the responsibility of the buyer, when utilizing TOSHIBA products, to comply with the standards of safety in making a safe design for the entire system, and to avoid situations in which a malfunction or failure of such TOSHIBA products could cause loss of human life, bodily injury or damage to property.
- In developing your designs, please ensure that TOSHIBA products are used within specified operating ranges as set forth in the most recent TOSHIBA products specifications. Also, please keep in mind the precautions and conditions set forth in the "Handling Guide for Semiconductor Devices," or "TOSHIBA Semiconductor Reliability Handbook" etc..
- The TOSHIBA products listed in this document are intended for usage in general electronics applications (computer, personal equipment, office equipment, measuring equipment, industrial robotics, domestic appliances, etc.). These TOSHIBA products are neither intended nor warranted for usage in equipment that requires extraordinarily high quality and/or reliability or a malfunction or failure of which may cause loss of human life or bodily injury ("Unintended Usage"). Unintended Usage include atomic energy control instruments, airplane or spaceship instruments, transportation instruments, traffic signal instruments, combustion control instruments, medical instruments, all types of safety devices, etc.. Unintended Usage of TOSHIBA products listed in this document shall be made at the customer's own risk.
- Gallium arsenide (GaAs) is a substance used in the products described in this document. GaAs dust and fumes are toxic. Do not break, cut or pulverize the product, or use chemicals to dissolve them. When disposing of the products, follow the appropriate regulations. Do not dispose of the products with other industrial waste or with domestic garbage.
- The information contained herein is presented only as a guide for the applications of our products. No responsibility is assumed by TOSHIBA CORPORATION for any infringements of intellectual property or other rights of the third parties which may result from its use. No license is granted by implication or otherwise under any intellectual property or other rights of TOSHIBA CORPORATION or others.
- The information contained herein is subject to change without notice.

Company Headquarters
 120 Broadway
 Menands, New York 12204
 Toll Free: 800.984.5337
 Fax: 518.432.7454



Web: www.marktechopto.com | Email: info@marktechopto.com

West Coast Sales Office
 950 South Coast Drive, Suite 265
 Costa Mesa, California 92626
 Toll Free: 800.984.5337
 Fax: 714.850.9314

TLOH160 Graphs

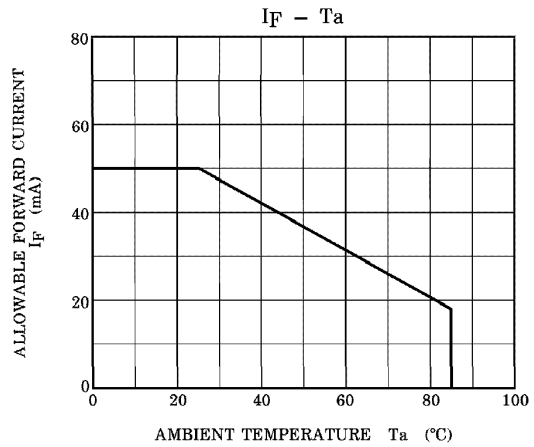
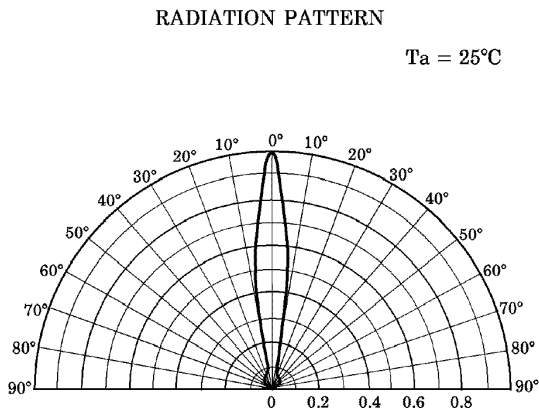
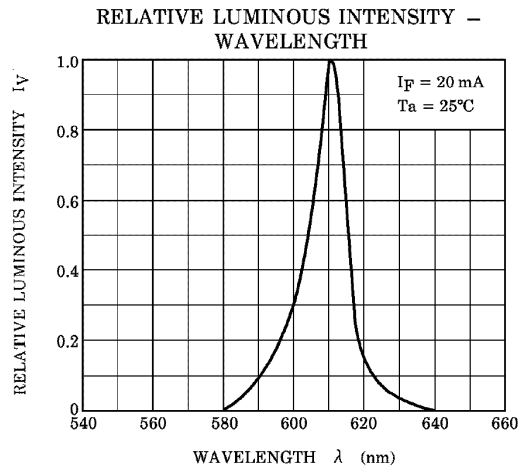
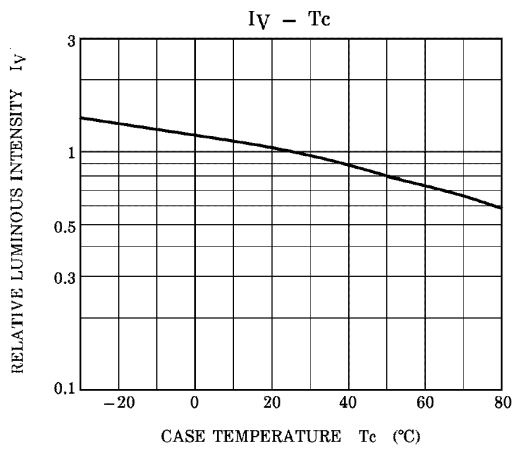
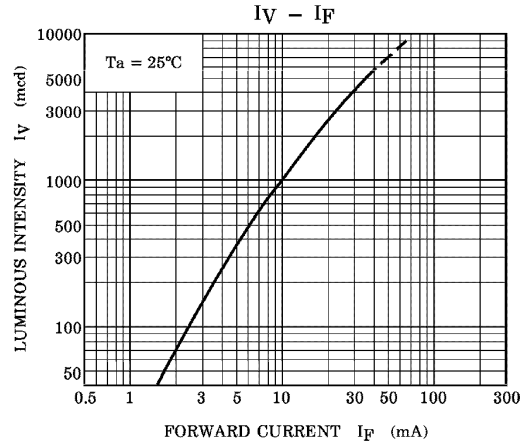
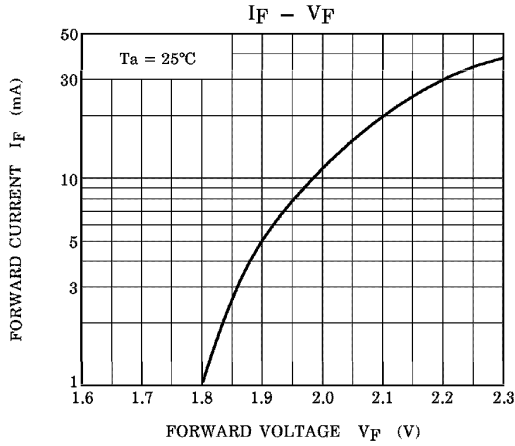

TLRH160 Graphs

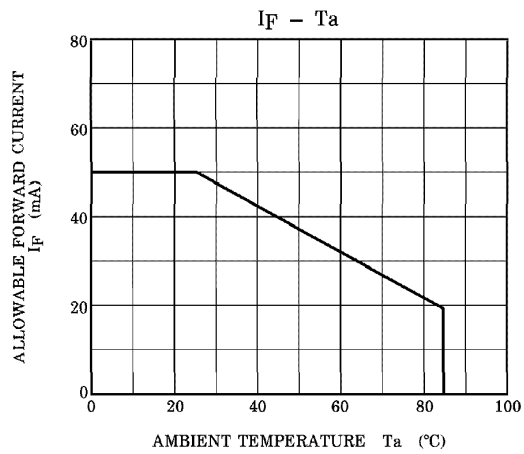
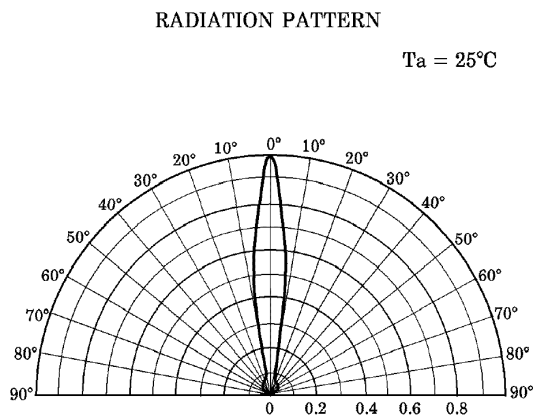
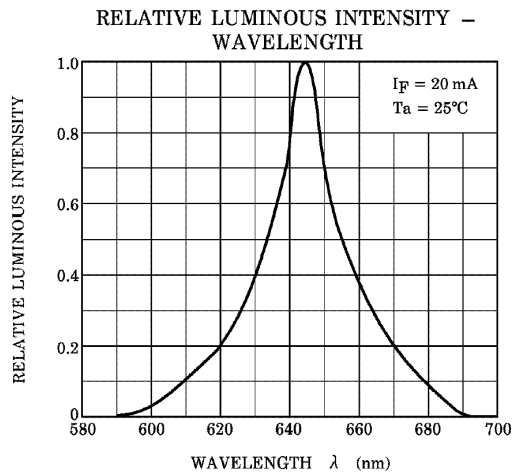
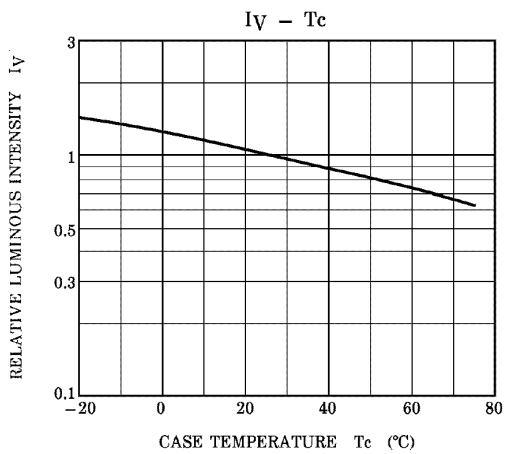
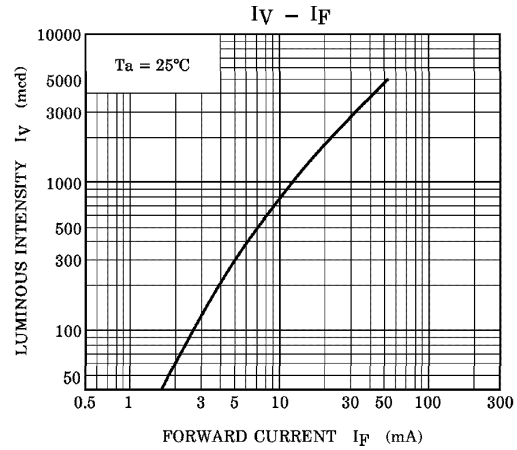
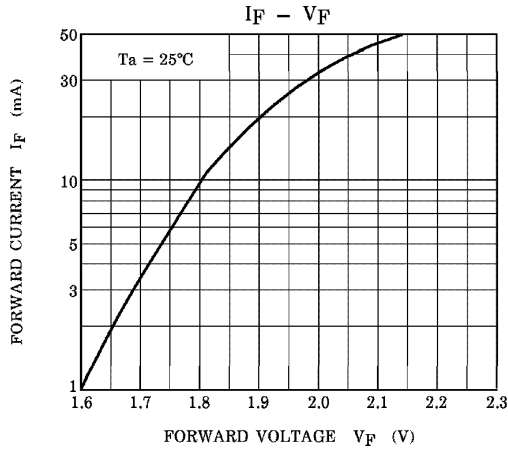

TLSH160 Graphs

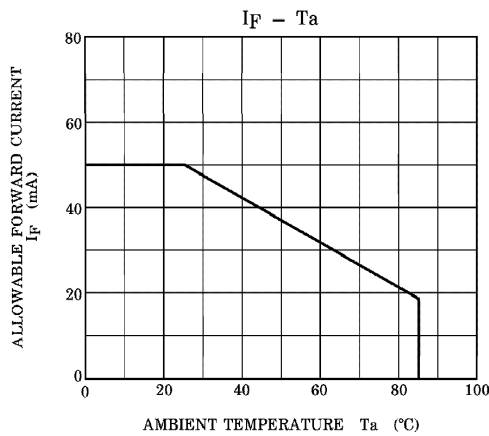
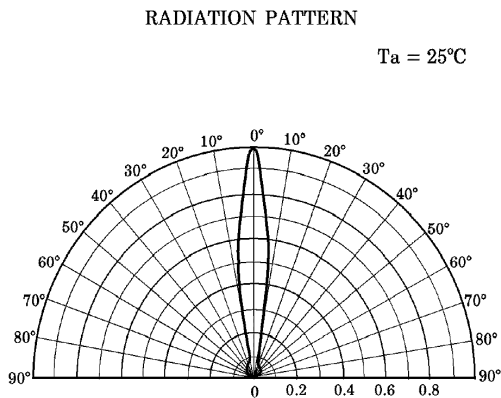
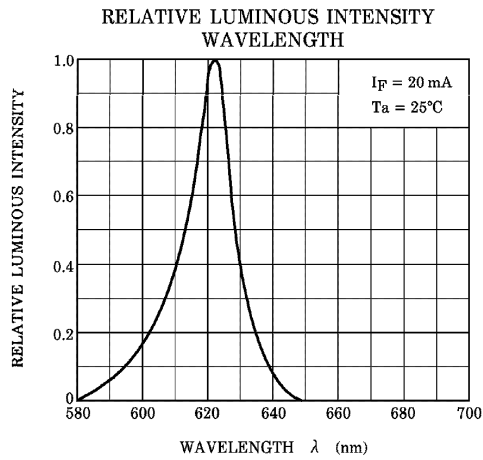
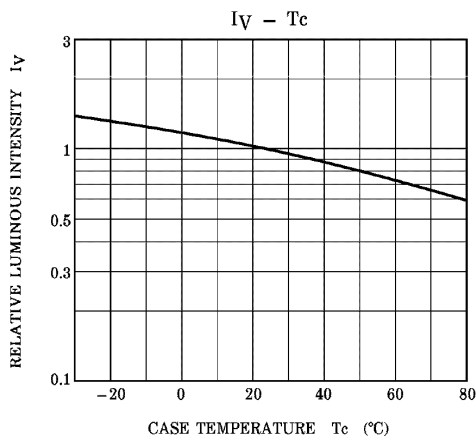
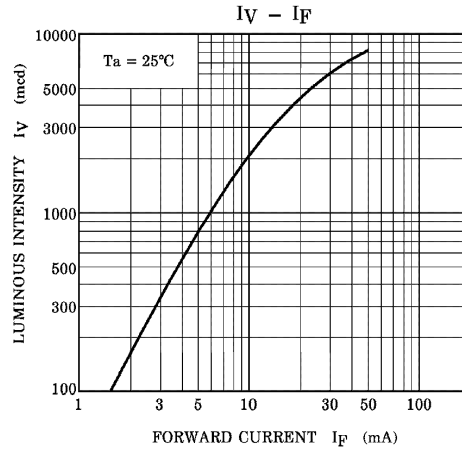
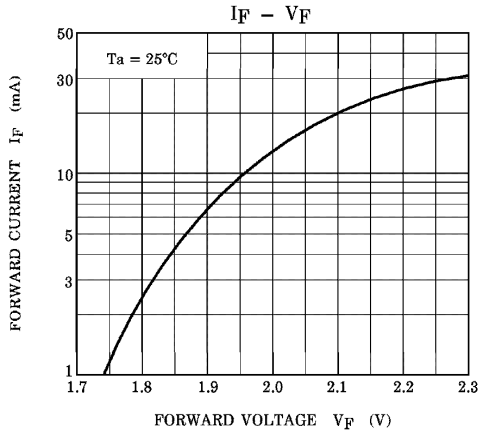

TLYH160 Graphs

